

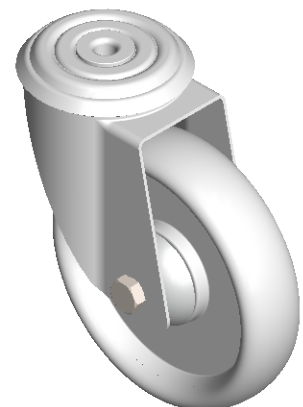

Copying of this document, and giving it to others and the use or communication of the contents thereof, are forbidden without express authority. Offenders are liable to the payment of damages. All rights are reserved in the event of the grant of a patent or the registration of a utility model or design.

Weitergabe sowie Vervielfältigung dieser Unterlage, Verwertung und Mitteilung ihres Inhaltes nicht gestattet, soweit nicht ausdrücklich zugestanden. Zuwiderhandlungen verpflichten zu Schadensersatz. Alle Rechte für den Fall der Patenterteilung oder Gebrauchsmuster-Eintragung vorbehalten.

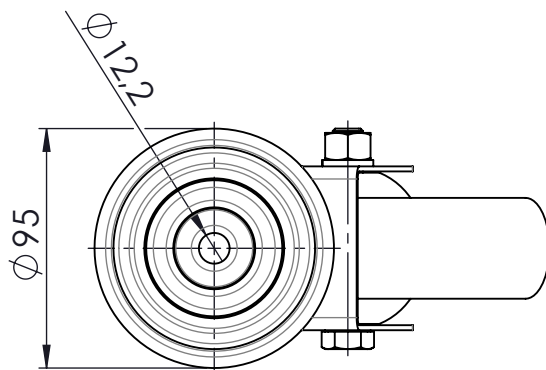
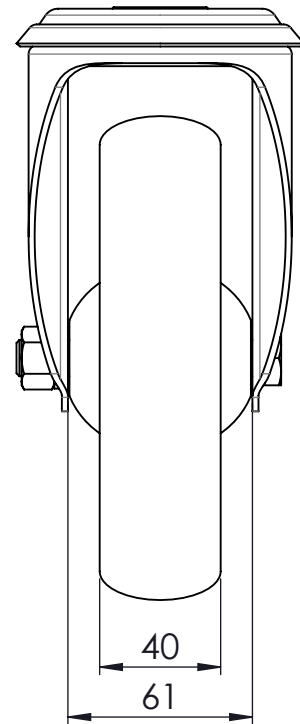
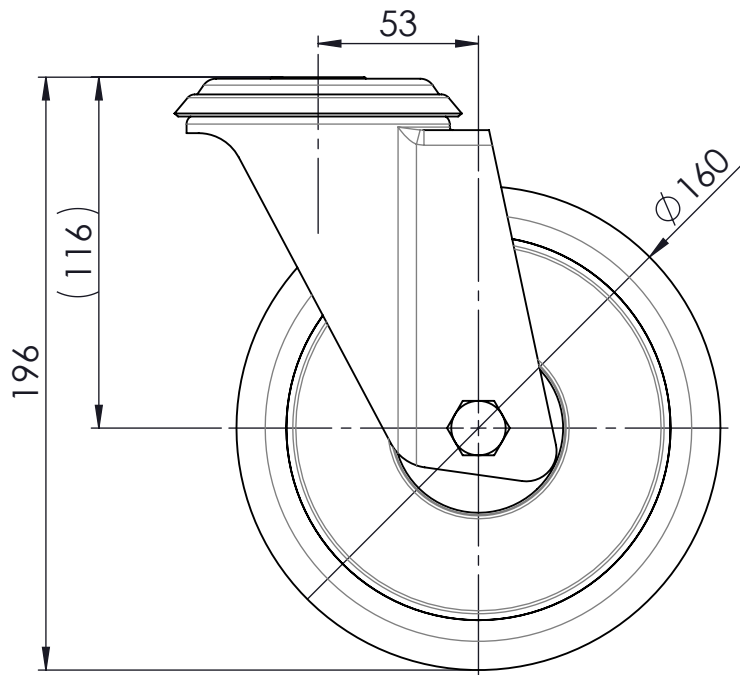

Artikelnummer <b>0030492</b>		Gewicht 1,2 kg	Erstellt von S.Born-Görke	Erstellt am 03.05.2021	Version A-01
		Beschreibung <b>Lenkrolle L-IV-PPBL-160-K-1</b>			
		Zchngs-Nr./Ident-Nr. 0030492_L-IV-PPBL-160-K-1			
Ind.	Änderung	Name	Datum	Blatt 1/1	